

# HYGROFLEX7



## THE HEAVY DUTY TRANSMITTER

INTRODUCING AIRCHIP DIGITAL TECHNOLOGY

### INNOVATION IN HUMIDITY AND TEMPERATURE MEASUREMENT

- Relative humidity, temperature measurement and dew point calculation
- Outstanding accuracy and repeatability
- Hygromer IN-1 Humidity Sensor
- Auto-diagnostics with error compensation
- All metal construction
- Freely selectable and scalable analog outputs



**rotronic**  
LEADING IN HUMIDITY MEASUREMENT

## SPECIFY THE BEST: HYGROFLEX7 ADVANTAGES AT A GLANCE.

The new HygroFlex7-series are equipped with sturdy metal housings and stainless steel probes for harsh industrial conditions. Based on AirChip3000 technology, this indicator achieves a degree of accuracy not seen before. Every transmitter can be used as a simulator with fixed values. This is a major advantage in system configuration and validation.

The HygroFlex7 transmitter offers, depending on the model, an application range of  $-100\dots+200^{\circ}\text{C}$ . Thanks to its fire protection classification, the instrument is perfectly suited for industrial applications, is convincing in process monitoring and in environments such as building management. Subway and tunnel construction also benefit greatly from the services provided by the HygroFlex7.

### Housing

- Robust industrial housing
- Ideal fire protection classification and degree of protection for your application
- All metal construction for wall, cable and duct versions

### Output signals

- Two freely selectable and scalable analog outputs
- Dew/frost point and moisture calculation
- 2-wire and 3/4-wire versions available
- Use as a simulator for system validation
- UART service interface



TECHNOLOGY

### AirChip3000

- Compensates humidity and temperature over 30,000 reference points
- 2,000 data point memory
- Dew/frost point calculation
- Sensor auto-diagnostics and automatic correction
- Active alarming and information
- ASIC (Application Specific Integrated Circuit), micro-controller and EEPROM on one chip

### Fast response and precise measurement

- Fixed mounted stainless steel probes for wall and duct mounts, cable probes with Teflon cables
- Superb system accuracy



## APPLICATIONS

The HygroFlex7 transmitters are ideal in harsh industrial environments. Whether in industrial applications, building management systems, underground railways, tunnelling etc. there is hardly a field today in which exact measurement of humidity, temperature and dew/frost point may be ignored. It is ultimately the measuring task at hand that defines the instrument that best meets your needs.

### HF7 wall mount

Building management system,  
Underground railways and tunnelling



### HF7 cable mount

Industrial processes in harsh environments,  
building management systems



### HF7 duct mount

Industrial processes in harsh environments,  
air delivery and exhaust equipment



## OUTPUTS OF THE HYGROFLEX7-SERIES

The high flexibility of the HygroFlex7-series allows the user to freely select the output parameters and the scale of each output. All you need to do is enter the desired settings using HW4 software (0...1V, 0...5V, 0..10V, 0/4...20mA).

### HF72-series

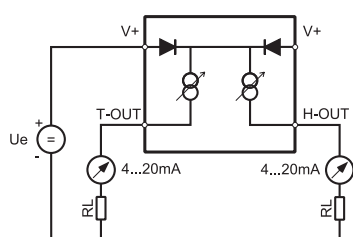

Schematic 2-wire type  
(current signal)

### HF73-series

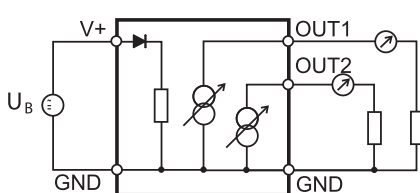

Schematic 3-wire type  
(current signal)

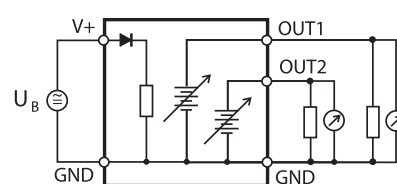

Schematic 3-wire type  
(voltage signal)

## TECHNICAL INFORMATION

### Probe Output Signal.

When connected to a PC the HygroFlex7-series probes can be rescaled with different ranges to suit the application. It is also possible to assign the internally calculated dew or frost point value to one of these outputs.

### Sensor Diagnostics.

The intelligence of AirChip3000 technology enables advanced sensor diagnostics. Should the sensors deviate from factory defined parameters, measurement values can be compensated automatically and a digital alarm triggered.

Wall mount (W)

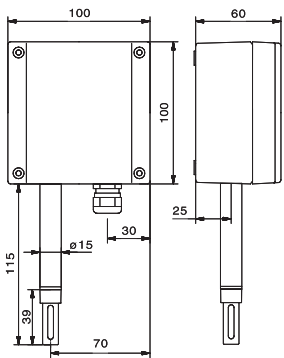

Cable mount (N) \*

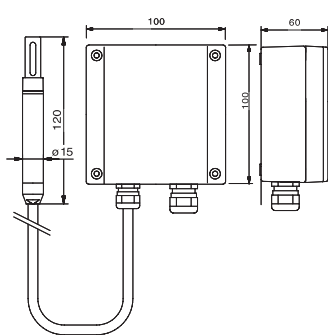

Duct mount (D)

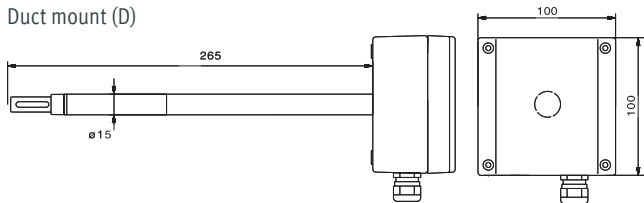

Duct mount (D) \*

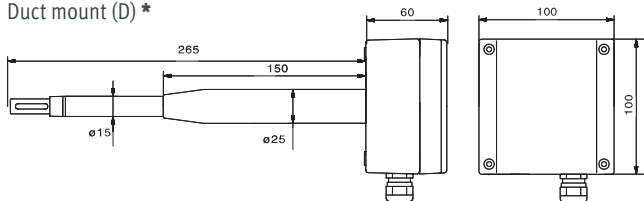

	HF72 2-wire	HF73 3/4-wire
Integrated sensors	Yes	
Humidity sensor	ROTRONIC Hygromer® IN-1	
Temperature sensor	Pt100 1/3 Class B	
Accuracy at 23 ±5 °C	±1.0 %rh / 0.2 K	
Resolution AirChip3000	<0.02 %rh / 0.01 K	
Long-term stability humidity sensor	<1 %rh / year	
Response time τ 63	<10 s	
Start-up time	Typical 1.4 s	Typical 1.9 s
Measurement range (probe)	-100...100 °C / 0...100 %rh (type W / A) * -100...150 °C / 0...100 %rh (type D) -100...200 °C / 0...100 %rh (type N) *	
Electronics operating range	-50...100 °C / 0...100 %rh (non condensing)	
Output signals	4...20 mA current loop 0...20 mA, 4...20 mA	0...1 V, 0...5 V, 0...10 V,
Change if signal U/I	HF73 only, without adjustment	
Power supply	10...28 VDC, 4...20 mA current loop	Depending on the output signal configuration
Power consumption	2x 20 mA, 4...20 mA current loop	<50 mA
Circuit types	2-wire types	3/4-wire type
Maximum load per analog output	0/500 Ω	0/500 Ω (current signal, min. 1000 Ω (voltage)
Firmware update	Yes, requires HW4 software	
Sensor Diagnostics	HW4 programmable. Default: off	
Sensor protection	Filter carrier (order filter separately)	
Maximum air velocity at probe	40 m/s - depends on filter type	
Adjustments	Yes, with HW4 software	
Data logging function Internal	Yes, 2000 data point memory	
Dewpoint /frostpoint calculation	Yes	
PC interface, UART	Yes, HW4 compatible	
Data processing by HW4	Graphs, statistics, analyses, qualification etc.	
Housing material / weight	Aluminium diecast / Approx. 800 g	
Cable connections	1 x M16x1.5 or 1/2" Conduit Adapter	
Standards	CE-compliant, 2007/108/EG	
Audit trail, Electronic Records	FDA CFR21 Part 11 and GAMP compliant	
IP protection rating & fire	IP65 (Incombustible)	

\* On demand: Special versions with PPS probe material (-100...+200°C)

Interested in further information (special applications, order codes)? A complete and up-to-date overview of our HygroFlex7-series is available on our web site [www.rotronic-humidity.com](http://www.rotronic-humidity.com).

Change over now to the HygroFlex7 transmitter and HygroClip2 probes with the integrated AirChip3000 for your humidity and temperature measurement needs. You can find detailed information about our probes at [www.rotronic-humidity.com](http://www.rotronic-humidity.com). We would also be happy to advise you in person or on the phone.

**rotronic**  
LEADING IN HUMIDITY MEASUREMENT

ROTRONIC AG, Grindelstrasse 6, CH - 8303 Bassersdorf, Tel. +41 44 838 11 11, Fax +41 44 836 44 24, [www.rotronic.ch](http://www.rotronic.ch)  
ROTRONIC Instruments (UK) Ltd, Crompton Fields, Crompton Way, Crawley, West Sussex RH10 9EE, UK, Phone +44 (0)1293 571000, Fax +44 (0)1293 571008, [www.rotronic.co.uk](http://www.rotronic.co.uk)  
ROTRONIC Instrument Corp, 160 E. Main Street, Huntington, NY 11743, USA, Phone, +1 631 427-3898, Fax, +1 631 427-3902, [www.rotronic-usa.com](http://www.rotronic-usa.com)